

MC664 -464 EXPANSION  
MODULES

3



# MC664 / MC464 Expansion Modules

## Assembly

A maximum of 7 half height modules or 3 full height modules may be fitted to the MC664 and MC464. A system may be made using any combination of half and full height modules providing that the full height modules are the last to be attached.

### MODULE SLOT NUMBERS

SLOT Numbers are allocated by the system software in order, left to right, starting with the lower bus. Lower modules are allocated slots 0 to m, then the upper modules become slots m+1 to n. Finally, the Sync Encoder Port is allocated slot n+1. The Sync Encoder Port has SLOT number -1 in addition to the one allocated (1) in this sequence.

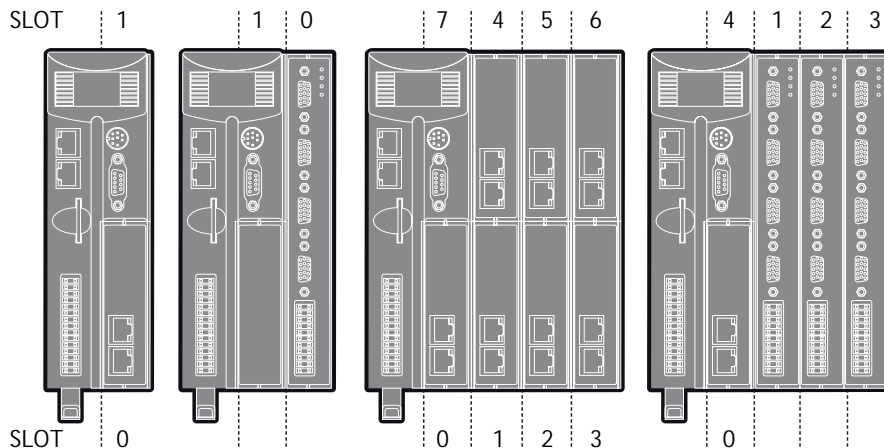

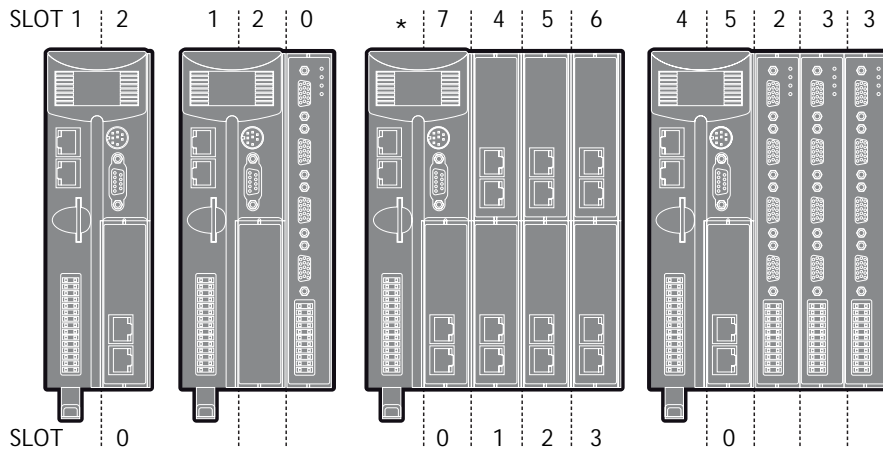

### FITTING EXPANSION MODULES

- Remove the 2 covers (B) if fitted to the MC664 or MC464 or to the previous expansion module (C).
- Locate the 2 hooks at the front of the module, while holding the rear out at an angle
- Push forward to engage the hooks and at the same time swing the rear of the module in so as to locate the connector.
- Press the connector “home” once it is located.
- Tighten the screw (A) using the tool provided or a small coin
- Clip the provided covers (B) in place as shown.

Removing modules is the reversal of the above procedure.

If the system is to be panel mounted, a kit (P8) comprising 2 x panel mounting brackets and 2 x countersunk screws may be purchased separately from your Trio distributor.

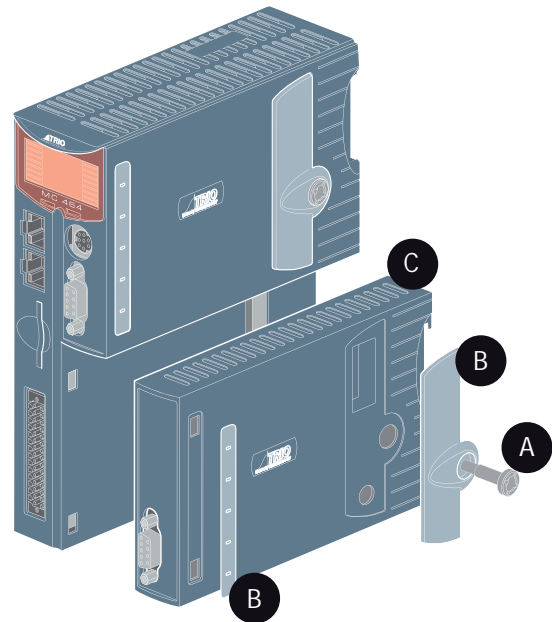

## RTEX Interface (P871)

For use with Panasonic amplifiers supporting the Panasonic Real Time Express (RTEX) network. Allows Plug & Play interconnection with Shielded twisted pair (TIA/EIA-568B CAT5e or more) Ethernet cables.

A single interface supports up to 32 axes on the RTEX network. The module comes with 2 axes enabled. Further axes can be enabled with Trio's Feature Enable Codes.

### REALTIME EXPRESS

The P871 communicates with up to 32 servo amplifiers using Ethernet Real Time Express. The physical layer is standard Ethernet connected in a ring. Each node has a transmit socket and a receive socket to allow easy connection. The maximum cable length between any 2 nodes is 60 meters and the overall network length is limited to 200 meters.



### RJ45 CONNECTOR (TX)



(Top connector) 100Mbps Panasonic RTEX transmit - connect to receive of first drive.

### RJ45 CONNECTOR (RX)



(Bottom connector) 100Mbps Panasonic RTEX receive - connect to transmit of last drive.

### TIME BASED REGISTRATION

Time based registration uses a 10MHz clock to record the time of a registration event which is then referenced to time stamps on the axis position from the digital drive network. An accurate registration position is then calculated. The 10MHz clock gives a time resolution of 100nsec. The position and speed of the axis are recorded so that the user can compensate for any fixed delays in the registration circuit.

Any time based registration input can be assigned to any Digital or Virtual axis. This makes the registration very flexible and enables multiple registration channels per axis. Each registration channel can be armed independently and assigned to an axis at any time.

### REGISTRATION CONNECTOR

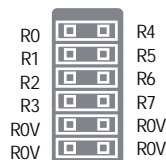

R0-R7 registration inputs (24V).

0V common 0V return.

Registration inputs can be allocated to any axis by software.

**LED FUNCTIONS**

LED	LED colour	LED function
ok	Green	ON=Module Initialised Okay
0	Red	ON=Module Error
1	Yellow	Status 1
2	Yellow	Status 2

## Sercos Interface (P872)

The sercos interface module is designed to control up to 16 servo amplifiers using the standard sercos fibre-optic ring. Benefits of this system include full isolation from the amplifiers and greatly reduced wiring.

For use with any sercos IEC61491 compliant drive. The module allows control of up to 16 axes via sercos with cycle times down to 250usec. Multiple sercos interface modules can be used to increase axes count to 64.

2, 4, 8 and 16 Mbit / sec

Software settable intensity

### SERCOS CONNECTIONS

Sercos is connected by 1mm polymer or glass fibre optic cable terminated with 9mm FSMA connectors. The sercos ring is completed by connecting TX to RX in a series loop. The maximum fibre cable length between 2 nodes is 40m for plastic optical fibre (POF) and 200m for hard clad silica (HCS). The total length for POF is 680m and 3,400 for HCS.



### CONNECTOR (RX)



(Top connector) sercos fibre-optic transmit. 9mm FSMA.

### CONNECTOR (TX)



(Bottom connector) sercos fibre-optic receive. 9mm FSMA.

### TIME BASED REGISTRATION

Time based registration uses a 10MHz clock to record the time of a registration event which is then referenced to time stamps on the axis position from the digital drive network. An accurate registration position is then calculated. The 10MHz clock gives a time resolution of 100nsec. The position and speed of the axis are recorded so that the user can compensate for any fixed delays in the registration circuit.

Any time based registration input can be assigned to any Digital or Virtual axis. This makes the registration very flexible and enables multiple registration channels per axis. Each registration channel can be armed independently and assigned to an axis on the fly.

## REGISTRATION CONNECTOR

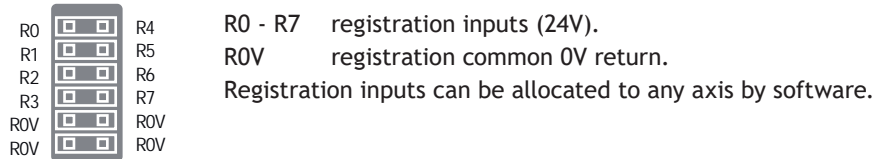

## LED FUNCTIONS

LED	LED colour	LED function
ok	Green	ON=Module Initialised Okay
0	Red	ON=Module Error
1	Yellow	Status 1
2	Yellow	Status 2

sercos phase	LED 1	LED 2
0	OFF	FLASH
1	OFF	ON
2	FLASH	OFF 1
3	ON	OFF 2
4	ON	ON



## SLM Interface (P873)

For use with drives supporting the Control Techniques SLM protocol. Each module supports 6 axes which can be individual drives or two drives using the CT Multi-ax concept.



### SLM CONNECTOR

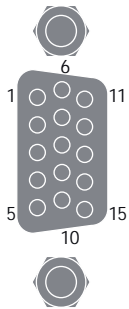

Pin	Upper D-Type	Lower D-Type
1	Com Axis 0	Com Axis 3
2	/Com Axis 0	/Com Axis 3
3	Hardware Enable	Hardware Enable
4	0V Output	0V Output
5	24V Output	24V Output
6	Com Axis 1	Com Axis 4
7	/Com Axis 1	/Com Axis 4
8	No Connection	No Connection
9	No Connection	No Connection
10	No Connection	No Connection
11	24V Output	24V Output
12	0V Output	0V Output
13	Com Axis 2	Com Axis 5
14	/Com Axis 2	/Com Axis 5
15	Earth / Shield	Earth / Shield

### TIME BASED REGISTRATION

Time based registration uses a 10MHz clock to record the time of a registration event which is then

referenced to time stamps on the axis position from the digital drive network. An accurate registration position is then calculated. The 10MHz clock gives a time resolution of 100nsec. The position and speed of the axis are recorded so that the user can compensate for any fixed delays in the registration circuit.

Any time based registration input can be assigned to any Digital or Virtual axis. This makes the registration very flexible and enables multiple registration channels per axis. Each registration channel can be armed independently and assigned to an axis on the fly.

### REGISTRATION CONNECTOR

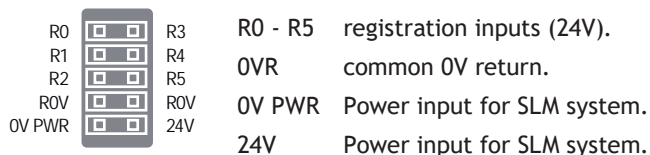

### LED FUNCTIONS

LED	LED Colour	LED Function
ok	Green	ON = Module initialised ok
0	Red	ON = Module error
1	Yellow	Status 1
2	Yellow	Status 2

## FlexAxis Interface (P874 / P879)

For use with Stepper, Analogue Servo & Piezo motors. The FlexAxis Interface is available in 4 axes (P879) and 8 axes (P874) versions.

Each axis provides a 16 bit analogue output, up to 8 x 24Vdc high speed registration inputs and a 6MHz encoder input. The encoder port can be configured to drive a stepper motor or an encoder simulation port, both at 2MHz.

### ENCODER CONNECTOR

Pin	Incremental Encoder	Pulse + Direction	Absolute Encoder
1	Enc. A n	Step+ n	Clock+ n
2	Enc. /A n	Step- n	Clock- n
3	Enc. B n	Direction+ n	n/c
4	Enc. /B n	Direction- n	n/c
5	0V Enc	0V Enc	0V Enc
6	Enc. Z n	Enable+ n	Data+ n
7	Enc. /Z n	Enable- n	Data- n
8	5V*	5V*	5V*
9	Enc A n+4	Step+ n4	Clock+ n+4
10	Enc /A n+4	Step- n4	Clock- n+4
11	Enc B n+4	Direction+ n+4	n/c
12	Enc /B n+4	Direction- n+4	n/c
13	Enc Z n+4	Enable+ n+4	Data+ n+4
14	Enc /Z n+4	Enable- n+4	Data- n+4
15	0V Enc	0V Enc	0V Enc

\*5V supply is limited to 150mA per axis.



Absolute encoder is only available on axes 4-7 on the P874 and on axes 2-3 on P879.

Connector	8 Axes (P874)	4 Axes (P879)
1	0 and 4	0
2	1 and 5	1
3	2 and 6	2
4	3 and 7	3

## MULTIFUNCTION CONNECTOR

The 22 pin multifunction connector provides terminals for 8 registration inputs, 8 voltage outputs and 4 hardware PSWITCH outputs.

## ANALOGUE OUTPUTS

8 +/-10V 16Bit analogue outputs are available for servo axis control (4 in the P879). Connect V0 as the velocity command signal for the first axis, V1 for the second axis and so on. The maximum load per axis together is 10mA.

## POSITION BASED REGISTRATION

Position based registration uses the encoder signal. When the registration event occurs the encoder position is latched in hardware. The speed of the axis is also recorded so that the user can compensate for any fixed electronic delays in the registration circuit. Flexible allocation of registration inputs to axes is provided. Each axis can have a number of registration events assigned to it and the source of these events can be from any of the registration channels.

The Flex Axis module has 8 registration inputs in addition to the Z mark for each axis. The first axis has 8 registration events which can be assigned to use any of the registration inputs or its own Z mark. The remaining axes have 2 registration events which can be assigned to use any of the registration inputs or their own Z mark.

## PSWITCH OUTPUTS

Inputs R4 to R7 are bi-directional and can be used as outputs for high accuracy PSWITCH operation. When used in this mode, the outputs are controlled by the position value of an axis within the same P874 / P879 module.



## MULTIFUNCTION CONNECTOR PIN OUT

DAC 0V		DAC 0V	0V	DAC common 0V return
DAC 0V		DAC 0V	V0 - V7	Voltage outputs
V0		V4	R0 - R3	24V Registration Inputs
V1		V5	R4/PS4 - R7/PS7	Bidirectional 24V registration In/24V: PSWITCH outputs
V2		V6	Inputs / 24V	PSwitch outputs
V3		V7	0V PWR	Power Input
R0		R4/PS4	24V	Power Input
R1		R5/PS5		
R2		R6/PS6		
R3		R7/PS7		
0V PWR		24V		



4 axis version uses voltage outputs V0 - V3 only.



Special versions are available for the 8 axis sSI and BiSS encoders.

## LED FUNCTIONS

LED	LED Colour	LED Function
ok	Green	ON = Module initialised ok
0	Red	ON = Module Error
1	Yellow	Status 1
2	Yellow	Status 2

## EtherCAT Interface (P876)

For use with EtherCAT compliant drives, this module allows control of up to 64 axes via standard shielded twisted pair (TIA/EIA-568B CAT5e or more) Ethernet cables. Multiple EtherCAT Interface Modules can be used.

EtherCAT is an open, high performance ethernet based fieldbus system, which has been integrated into several IEC standards (IEC 61158, IEC 61784 and IEC61800). It is a high performance, deterministic protocol, with high bandwidth usage, low latency and low communication jitter. Various network topologies are supported, including line, tree or star. The EtherCAT compliant servo amplifiers from any number of vendors may be included in a network.

The module supports both the CANopen and servo drive (sercos, IEC 61491) EtherCAT profiles, along with the mailbox transfer protocol to exchange configuration, status and diagnostic information between the master and slave.



### RJ45 CONNECTOR



100 base-T Ethernet (EtherCat Master).

### TIME BASED REGISTRATION

Time based registration uses a 10MHz clock to record the time of a registration event which is then referenced to time stamps on the axis position from the digital drive network. An accurate registration position is then calculated. The 10MHz clock gives a time resolution of 100nsec. The position and speed of the axis are recorded so that the user can compensate for any fixed delays in the registration circuit.

Any time based registration input can be assigned to any Digital or Virtual axis. This makes the registration very flexible and enables multiple registration channels per axis. Each registration channel can be armed independently and assigned to an axis on the fly.

## REGISTRATION CONNECTOR

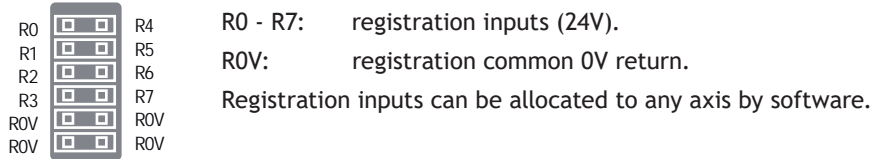

## LED FUNCTIONS

LED	LED colour	LED function
ok	Green	ON=Module Initialised Okay
0	Red	Quick Flash = Module Error Slow Flash = Not in operational state
1	Yellow	Status 1
2	Yellow	Network Activity

## Anybus-CC Module (P875)

Open communications is an important aspect to any control system. This module adds support for the Anybus CompactCom device modules.

Anybus-CC is a plug-in module supporting all major Fieldbus and Ethernet networks. Its innovative design and versatile functionality offers the Anybus-CC optimal flexibility for OEM manufacturers.

The Anybus modules can be found at: [www.anybus.com](http://www.anybus.com)



Anybus CompactCom Module shown for illustration only. Anybus CC Modules may be purchased separately.

Anybus CC Modules support (firmware v2.0263).

- AB6211 CC-Link
- AB6201 DeviceNet
- AB6200 Profibus
- AB6216 EtherCAT
- AB6224 Ethernet/IP 2 port
- AB663 Modbus TCP 2 port
- AB6221 Prifinet-IO 2 port



### ANYBUS MODULE FITTING

Push the Anybus® module (A) into the Trio Expansion Interface taking care to keep its base in contact with the PCB and align guide slots (B) with the connector rails inside.

Ensure that the moulded hooks (C) on the lower front edge of the Anybus® module locate under the P875 PCB at the front.

When the module is flush with the face of the Trio Expansion Interface, tighten the two “Torx” head screws (D) to locate the two lugs (E) and secure the Anybus® module.

To remove the module, reverse this procedure.

